

SmartPulse™ Low Voltage High Resistance Grounding System

Installation, Operation and
Maintenance Instructions

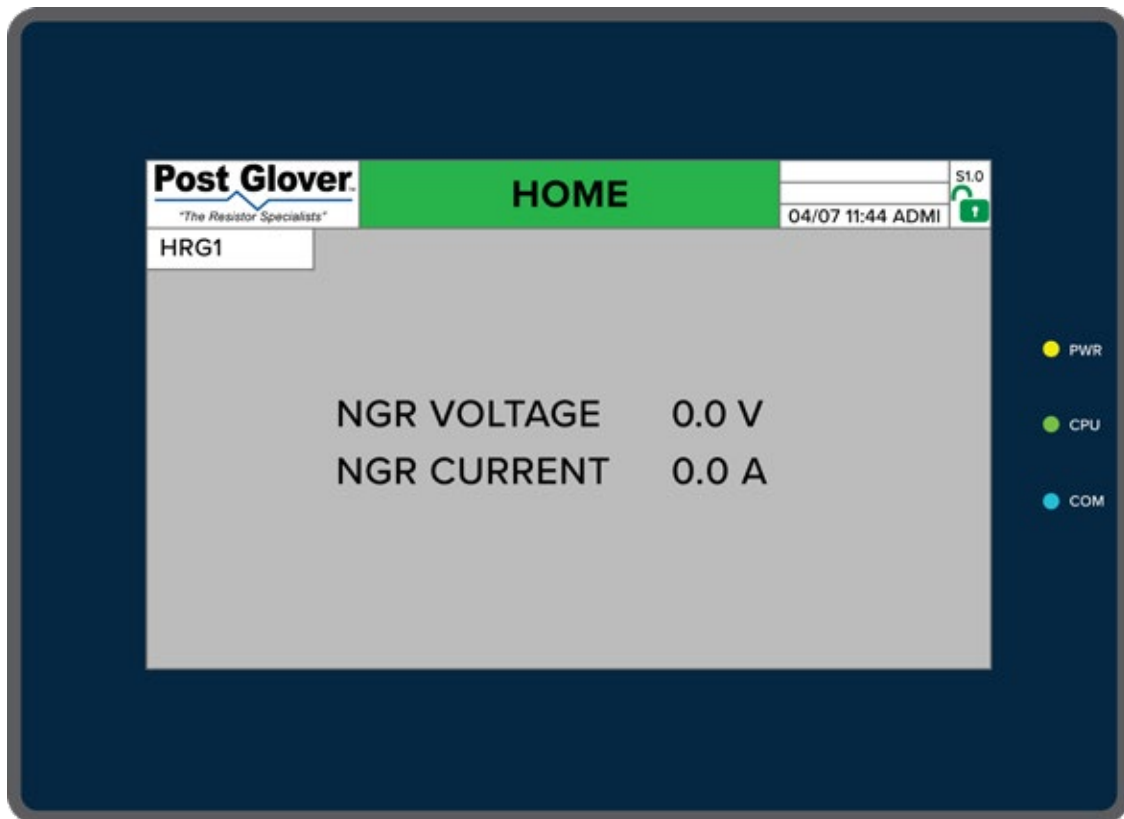

page intentionally left blank

Table of Contents

Section 1 – Equipment Overview	4
Section 2 – Installation	7
Section 3 – Start-up Guide	10
Section 4 – Operational Description	14
Section 5 – Charging Current & Resistor Tap Setting	22
Section 6 – Locating a Ground Fault/Using Pulse	24
Section 7 – Neutral Health Monitoring.....	25
Section 8 – Password Protection and User Permissions	26
Section 9 – Troubleshooting Alarms and Events.....	28
Section 10 – Maintenance	30
Section 11 – Troubleshooting by Symptom	31
Appendix A – Dimension Drawings, Low Voltage Enclosure.....	32
Appendix B – Customer Connection Details	33
Appendix C – Control Specifications	35
Appendix D – Setup Report Form	37

Section 1 – Equipment Overview

1.1 Exterior View – Standard Single HRG Cabinet

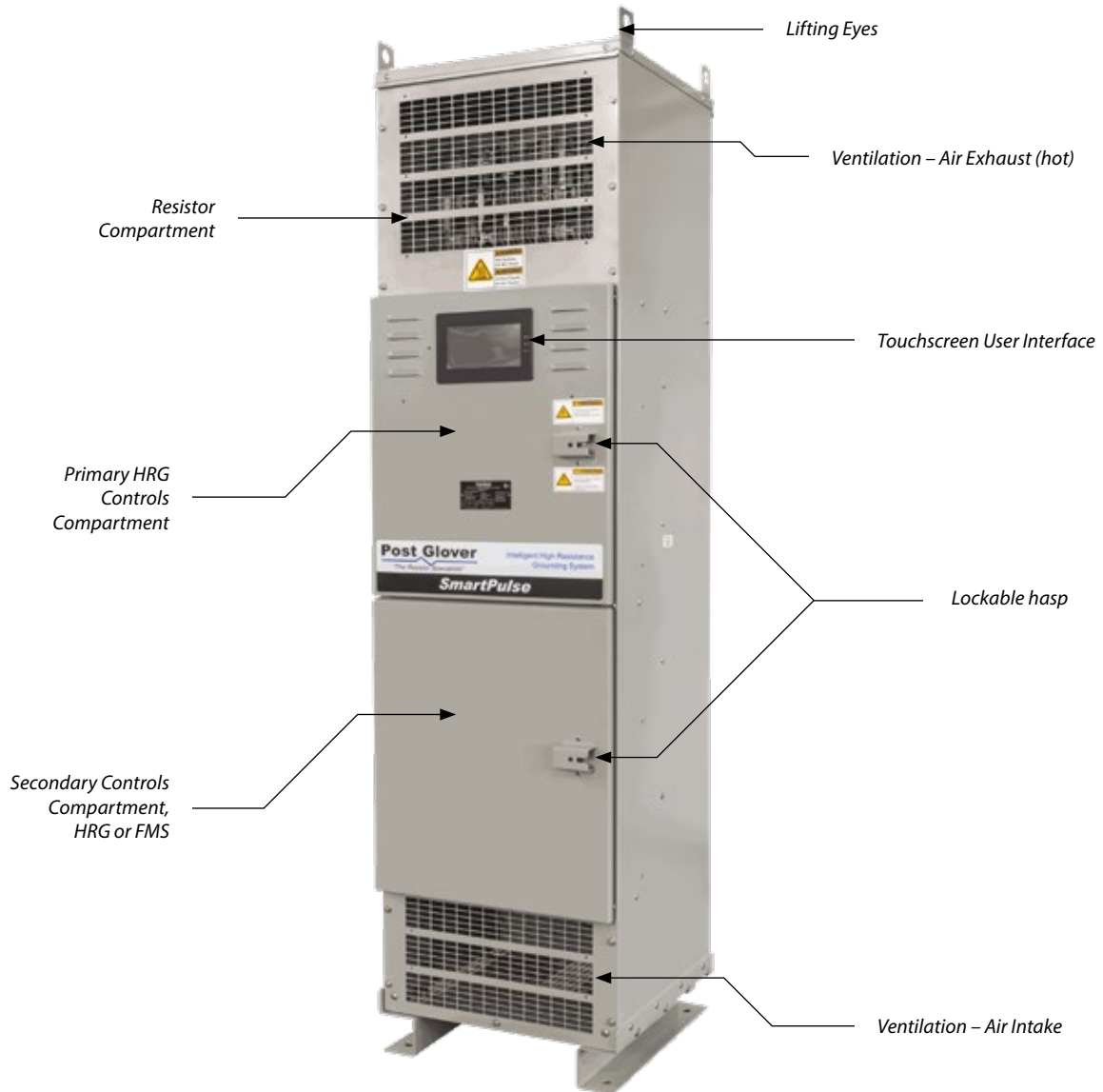

Acronyms

NGR	Neutral Grounding Resistor	LDEM	Low-Voltage Digital Electronics Module
HRG	High Resistance Grounding	SRE	Smart Relay
HMI	Human Machine Interface	FMS	Feeder Monitoring System

SMARTPULSE™ INSTRUCTION MANUAL

1.2 Interior View – Standard Control Panel

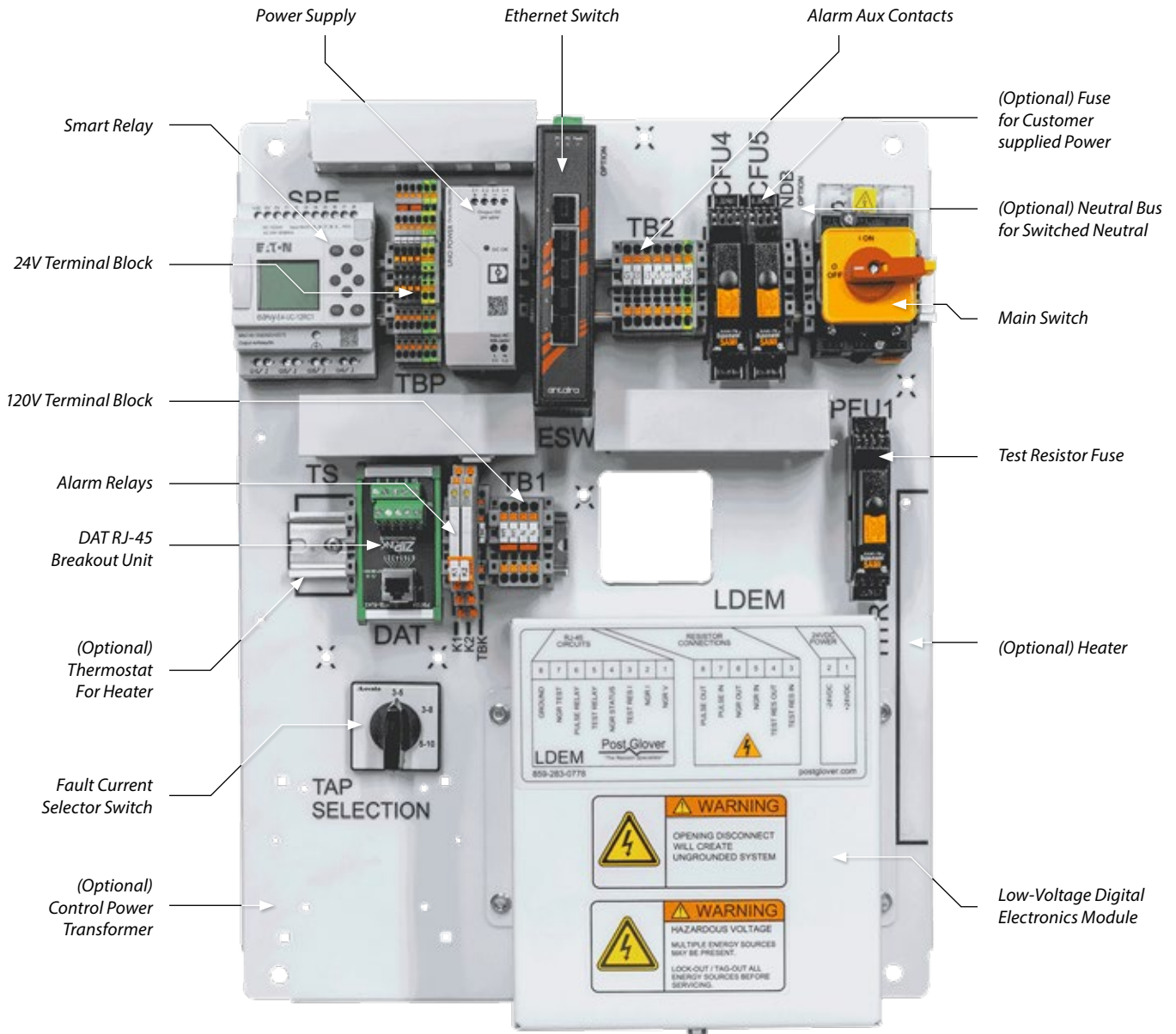

1.3 Interior View – Resistors

- Stepped Neutral Ground Resistor (NGR).
- Included test resistor and resistors for Pulsing.
- Desired fault and pulsing current can be set using the resistor selector switch. *See section 5.2 for further detail.*

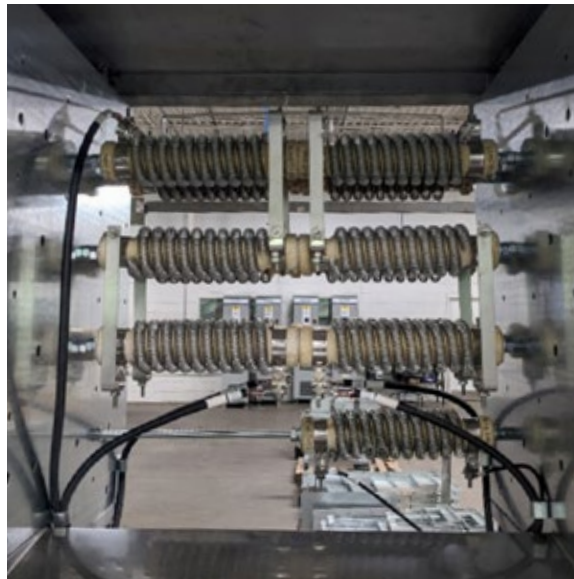

1.4 HMI Home Screen

See section 4 for more detail on operating the unit through the HMI.

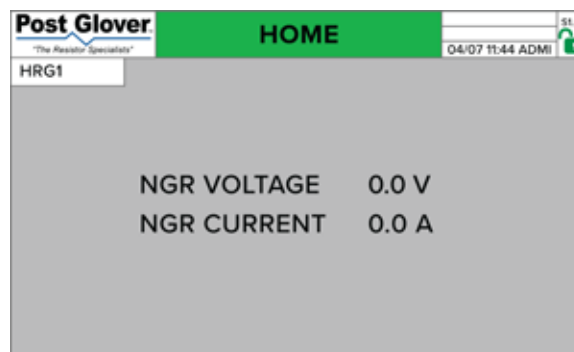

Section 2 – Installation

This instruction booklet is intended as a general guidance tool for personnel installing Post Glover Resistors High Resistance Grounding Systems. However, each unit is designed for a specific application/installation.

Please refer to the drawings supplied with your unit for ratings and other information. Appendix A contains dimension drawings with information for standard low voltage systems. Consult all specific equipment drawings furnished by Post Glover Resistors, Inc., for your particular installation.

WARNING: *Install only in access restricted locations.*

AVERTISSEMENT: *Installer seulement dans des endroits auxquels l'accès est limité.*

2.1 Receiving

A preliminary inspection of the crate (or enclosure) should be made at this point to ensure that the unit was handled properly during shipment. If damage is detected, contact the carrier immediately to file a claim.

2.2 Handling

Once received, the high resistance grounding unit should be unloaded and carefully moved by overhead crane. Free-standing units have removable lifting angles for an overhead crane to use when moving the unit. Loosen and rotate the lifting angles 180° and re-tighten before using to lift the unit. Do not attempt to move or lift the unit at points other than the lifting angles. Always store the unit upright to avoid damaging the enclosure and/or controls. Do not stack the units.

2.3 Inspection

Inspect the enclosure for any signs of shipping damage such as dents, scratches or chips. Inspect the inside of the enclosure for any loose wiring or bolts. Check the resistor for any signs of broken insulators or elements.

2.4 Storage

If the unit will be stored for some length of time, take the following precautions:

1. Remove the crate and thoroughly inspect the unit.
2. Store the unit in an area that is clean and dry and has moderate temperatures. Cover it with a heavy-duty plastic cover or cloth.
3. To prevent condensation in units stored in damp areas, provide 120-200 watts of heat for the duration of the storage period.

2.5 Floor Preparation

The equipment foundation must be designed with suitable strength and levelness. Sufficient height should be allowed above the unit to allow conduit to enter at the top of the unit if that is the desired entry point. The purchaser is responsible for anchoring the unit to the floor with anchors of suitable strength.

WARNING: When mounting on or over a combustible surface, a floor plate of at least 1.43 mm galvanized steel or 1.6 mm uncoated steel extending at least 150 mm beyond the equipment on all sides shall be installed.

AVERISSEMENT: Lorsque l'appareil est installé sur ou au-dessus d'une surface combustible, on doit prévoir une plaque d'acier galvanisé d'au moins 1.43 mm ou une plaque d'acier sans revêtement de 1.6 mm se prolongeant sur au moins 150 mm tout autour de l'appareil.

2.6 Grounding... CAUTION!

To reduce the possibility of electric shock, the unit must be properly grounded before making any system power connections. Connect the system ground to the ground bus located in the lower portion of the free-standing units. For the wall-mount units refer to the unit specific drawings to find the ground connection locations. Make sure that all ground conductors are sized per the NEC (NFPA 70).

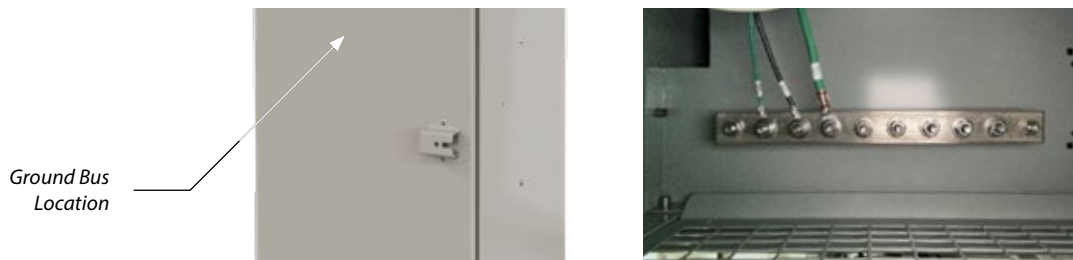

2.7 Line and Control Connections

Refer to application specific drawings that accompany the Post Glover Resistors system. The free-standing enclosure is designed to accommodate the line cables through the sides of the enclosure without unnecessary cable bends. The control power connections made to the terminal blocks are rated for 20 amperes, 600 volts. The auxiliary device connections made to the terminal blocks are rated for 3 amperes at 120/230 VAC, 2 amperes at 24 VDC, and 100mA at 220 VDC.

Refer to the specific diagrams furnished with the equipment for location detail.

As a final check, inspect all wiring to verify that connections are made properly and that they are clean and tight. Make sure there is adequate clearance between the external connections and all devices.

NOTE: It is possible for the electrical connections to loosen during transit. Check all electrical connections to ensure they are firmly tightened.

NOTE: Consult local NEC codes for proper cable sizing.

2.8 Setting Ground Fault/Pulsing Levels

The ground fault and pulsing current levels can be chosen using the selector switch. Turn the dial to the desired setting. The first value on the switch setting is the value for the ground fault current, the second value is the current that will occur during a pulse operation. For user safety do not turn the selector switch with an active ground fault.



NOTE: Do not connect the neutral connection (N) directly to ground. This results in a solidly grounded system and disables any benefits and protections of the HRG system.

2.9 General

When the installation is complete and all incoming wiring has been terminated, clean the inside of the unit with a soft cloth or vacuum cleaner. Make sure any dirt or debris, such as packing material, is removed so it does not interfere with the operation of the unit. Before connecting power to the control panel, check all components to make sure all shipping devices, such as blocking or tying of relays, have been removed.

Section 3 – Start-up Guide

This quick start guide provides a brief overview of the steps required to use this High Resistance Grounding Equipment, but **is not meant to be a substitute for reading the entire manual**. Please refer to section 4 for setting suggestions or reasons to change from default.

3.1 Physical Installation

Once removed from the shipping pallet and packaging, secure the unit to the floor using the provisions in the base. In one of the conduit entry areas noted on the delivered unit enclosure drawings, cut an appropriate access hole to bring in the required connection. See page two of the included wiring schematic for detail on the required connections. The ground connection can be routed through the same opening or if more convenient, a second entrance can be added in another location.

NOTE: Any work performed on this unit should be done by qualified persons and must be done in compliance with national, regional, local and site-specific safety procedures. It is the responsibility of the owner to comply with all applicable electrical codes.

3.2 Pre-energization Checks

Perform the following checks before energizing the HRG unit:

- Inspect the enclosure interior for connections that may have come loose in shipping.
- Check continuity of all fuses.
- Open SW1
 - For units on a wye system ensure that the transformer X0 is only connected to the HRG unit. SW1 Terminal 1 to the ground bus should produce ∞ , OL, resistance. Also check the resistance from terminal 2 of the disconnect switch to ground. This should match the drawing value for the default resistor tap. **Default value is 55 Ω for 5A ground fault.**
 - For units on a delta system check the resistance from LDEM terminal 5 to ground. This should match the drawing value for the default resistor tap. **Default value is 55 Ω for 5A ground fault.**
- If the unit is equipped with an anti-condensation heater, verify the thermostat is set correctly for your environment.

3.3 Electrical Connection and Start-up

Connect the required phases (2 for wye units with control power transformer, one for wye units with customer supplied power, and three for delta units) to the appropriate points on the disconnect switch. Connect the internal ground bus to the system ground. See Appendix B for recommended wire sizes.

NOTE: Opening the disconnect switch may remove power to the unit and/or the grounding resistor from the circuit. The system is ungrounded while the disconnect switch is open.

SMARTPULSE™ INSTRUCTION MANUAL

After the mechanical installation and all wiring is completed per specific equipment drawings furnished by Post Glover Resistors, Inc., place the system in service by following these steps:

3.3.1 Power the system by closing SW1 and control power if it is separately derived. The Home Screen will be displayed.

3.3.2 Note initial NGR Voltage and Current. When systems are first installed, any parasitic capacitance, system insulator breakdown, or fault will be evident by the NGR Voltage and Current. Normal NGR voltage is less than 5V and normal NGR current is less than 0.108A. Typically, Voltage or Current above these values indicate insulation breakdown, wet conductors, or a phase being grounded. The lower the voltage, the higher the resistance of the ground connection.

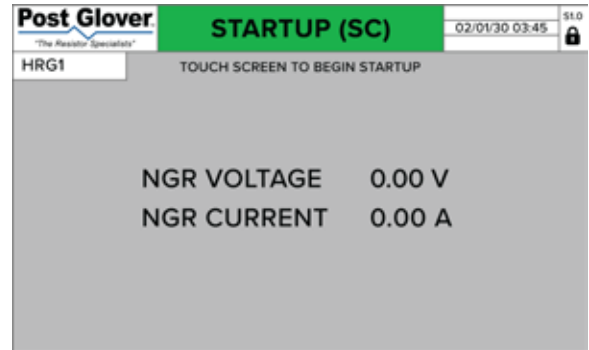

NOTE: Default NGR Voltage alarm value, **OVERVOLTAGE ALARM**, is 100V, and the default NGR Current Alarm value, **OVERCURRENT ALARM**, is 4A. NGR Voltage or Current above these values will produce an alarm. If there is an active fault upon power up, the alarm screen will display, the red fault light will be flashing and the alarm horn will sound. See section 9 for a full list of alarms.

3.3.3 Disable the password by first touching the lock icon in the top right corner.

If administrator is not listed as **USER NAME** click the drop-down arrow and select "administrator".

Click the password box currently displaying "0". Enter "3000" followed by enter.

Click **Login**.

The lock icon in the top right corner should now be open.

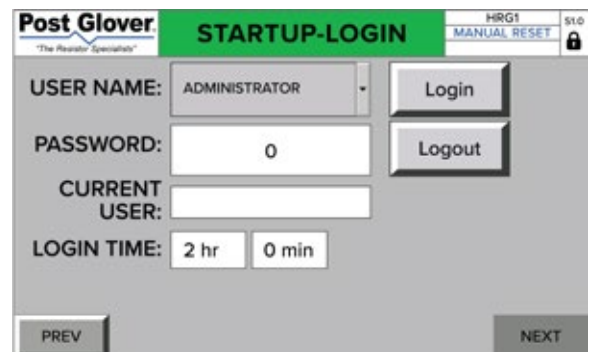

SMARTPULSE™ INSTRUCTION MANUAL

3.3.4 Name device and verify factory settings.

If desired changed the device name by press the white box with the default “HRG1” title.

Confirm that the System Voltage matches the Line-to-Line voltage of the system being grounded.

Confirm that the Ground Current Tap and The Pulse Current Tap settings match the selected values on the cam switch.

Confirm the Test Current Tap matches the specified test current for the unit.

If any of these settings need to be changed simply click the numerical value to bring up the touchpad to adjust the setting.

3.3.5 Perform the Device Checklist and verify the desired settings.

Check the various items on the device checklist.

Once the item is deemed acceptable touch the white box next to the item to check it off. Check all the listed items and touch the **NEXT** button.

The next three screens consist of the time, alarm, and sensing settings. To change a setting simply press on the numerical value and enter the desired value. *These settings will be covered in detail in section 4.*

Press the **NEXT** button to continue the start-up process.

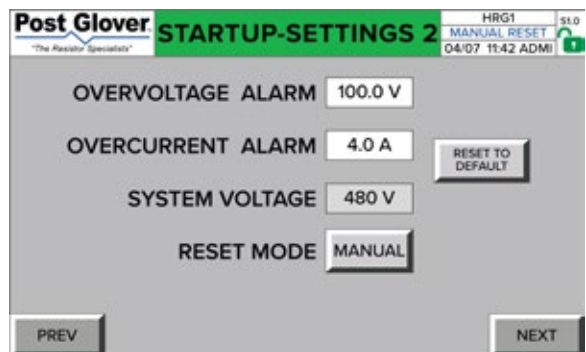
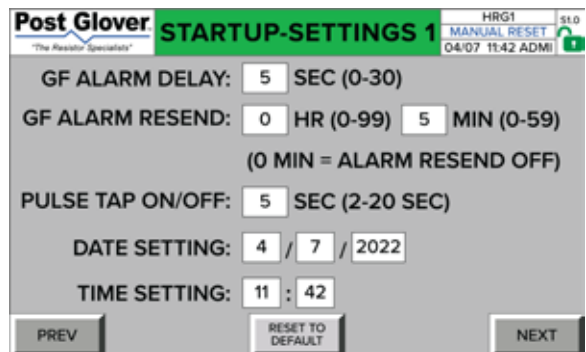
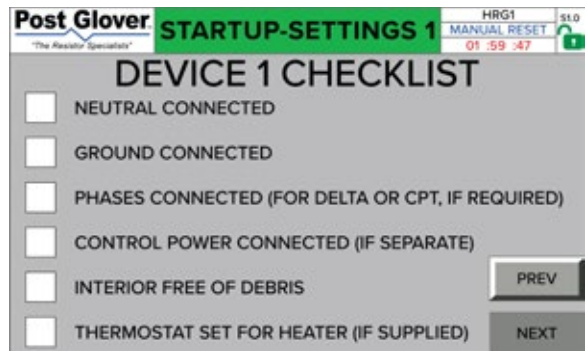
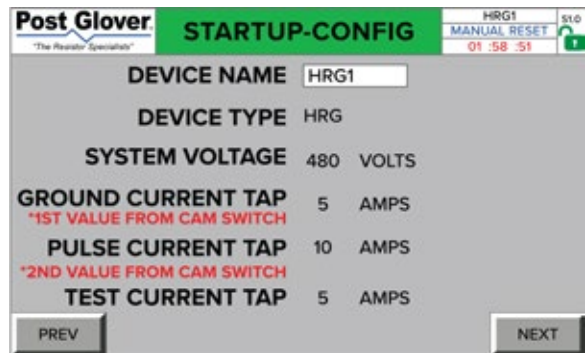

3.3.6 Perform a Ground Fault Test and a Ground Fault Pulse Test.

To begin a ground fault test press the **START** button.

The unit will short phase C to ground through the test resistor. This should produce a voltage and amperage on the NGR. There should also be an amperage on the Test Resistor. These values should be within 20% of the calculated values.

After 10 seconds the unit should alarm, this is the sign of a passed test.

If the unit does not alarm or an error screen is produced *see section 11 Troubleshooting*.

After running a successful ground fault test press the **NEXT** button to proceed to the ground fault pulse test.

Now press the **START** button ground fault and pulse test. This test will be exactly as the previous test except after 10 seconds the unit will begin to pulse. During the pulse cycle you should see the amperage on the unit increase and decrease on 2 second increments.

Upon completion of the Ground Faults Tests press next.

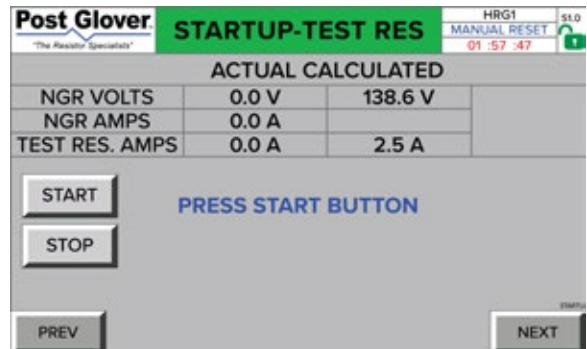

3.3.7 Perform a System Charging Current Test.

Press the **START** button to begin the System Charging Current Test.

Similar to the earlier test a phase will be faulted through the test resistor.

After 5 seconds the unit will return a calculated system charging current value.

The Ground Fault tap must be set to a value higher than this value for proper operation.

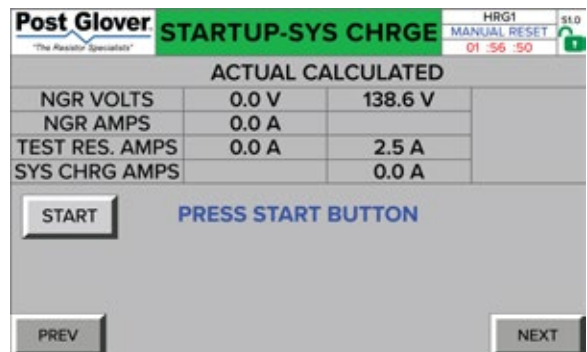

NOTE: The System Charging Current is a critical test and is used to determine the NGR Tap Setting as well as the minimum OVERCURRENT ALARM setting. See section 5.1 and section 5.2 for more information.

3.3.8 Calibrate Neutral Health Sensing. This screen offers the opportunity to calibrate the NGR after the system is running, as well as modify settings. Follow complete instructions in 4.4.3.

3.3.9 Commissioning is now complete. Press complete to enter normal operation.

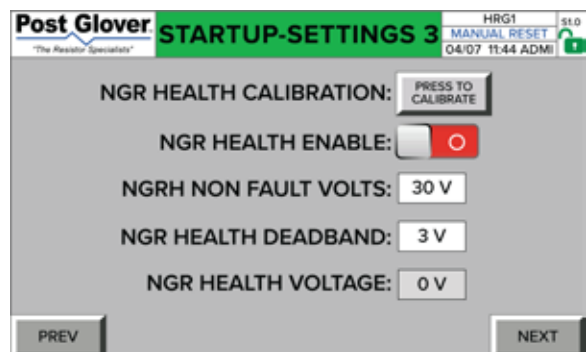

Section 4 – Operational Description

4.1 HRG Functions

The Post Glover Resistors SmartPulse High Resistance Grounding System Equipment (HRG) coordinates the use of resistors and monitoring devices to create a high resistance ground for a power system. When a phase to ground fault occurs, the Neutral Grounding Resistor (NGR) limits the fault current. The monitoring components display, log, and can communicate information pertaining to the fault and system events. The information can be viewed on the local User Interface or over the facility network.

4.2 Home Screen

The HMI is used to monitor, setup, test, communicate, and provide diagnostic tools for the SmartPulse HRG.

4.2.1 The Center of the Home Screen displays the NGR Voltage and NGR Current.

4.2.2 The unit device name will be displayed in the top left corner.

4.2.3 The password status is displayed in the top right corner. A black closed lock indicates that the unit is currently password protected. A green open lock indicates that the password has been entered and the unit is unlocked for changes and tests. If the unit is unlocked a timer will also be displayed. When this timer reaches 0 the unit will lock itself.

4.2.4 If the screen is solid red or flashing red the unit currently has an alarm press anywhere to get to the system screen for more detail.

4.2.5 The software version is displayed in the upper right corner of the Home Screen.

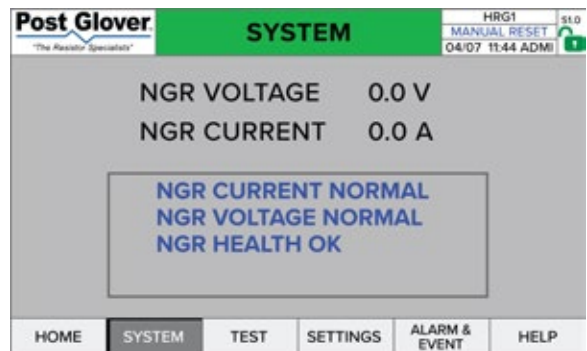
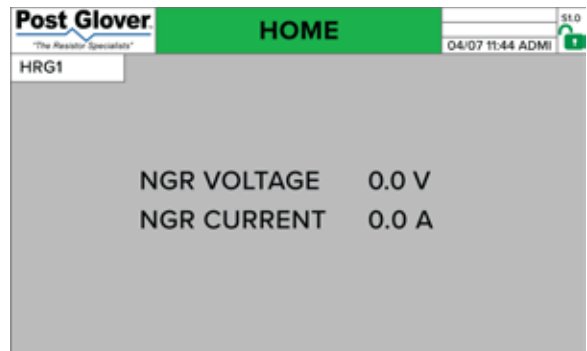

4.3 System Screen

4.3.1 From the Home Screen, pressing anywhere on the screen accesses the System screen.

The system status screen displays the voltage and current actively on the unit and the status of any alarms on the unit.

If an alarm is present on the unit the screen will be red and show details about the alarm. If applicable the options for pulsing and system reset will displayed.



4.4 Settings

4.4.1 Alarm Settings

From the System Screen, pressing the Settings button at the bottom of the screen allows parameters to be viewed or set through the setup menu. The following parameters have default values to allow for ease of setup. Password protected parameters can be modified to customize the system monitoring.

NOTE: Before any settings can be changed the password must be disabled. See more information on section 8.

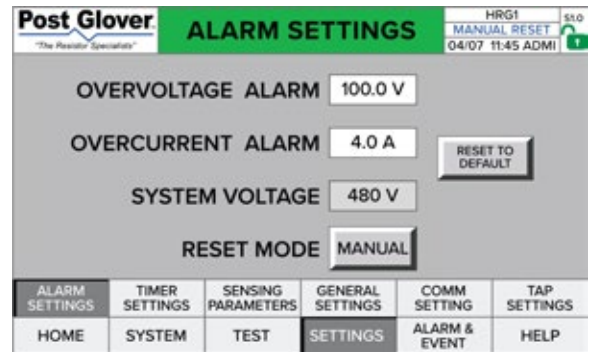

The Alarm settings are used to determine if a ground fault has occurred, or a circuit has opened. Any conductive path from the power system phase to ground will conduct zero sequence current back to the system transformer X0 through the NGR. The voltage across the NGR and the current through the NGR will be dependent upon the resistance of the phase to ground path. A direct bolted fault to ground on a 480 VAC system will produce approximately 277 VAC across the NGR. The current flowing through the NGR will be dependent upon the tap setting of the resistor bank. The default Tap N5 will allow approximately 5A of current to flow.

4.4.1.1 Overvoltage Alarm

The NGR Over-voltage setting (OVERVOLTAGE ALARM) is used to alarm when Ground Faults exist. The alarm “**NGR OVERVOLTAGE**” will be triggered if the voltage on the neutral exceeds this value.

A Ground Fault Test with typically installed test resistors and the default NGR tap will produce more than the default setting of 100 Volts. Performing a ground fault test will display the NGR voltage present during the test. Expected Ground Fault test voltage can be calculated with the following formula.

$$V_{TEST} = (V_{L-N} / (R_{GF} + R_{T-G})) R_{GF} - 10V$$

Where: V_{TEST} is the test voltage to be temporarily entered for the Over-voltage setting V_{L-N} is the line-to-neutral system voltage

R_{GF} is the resistance of the neutral grounding resistor at the chosen tap. N5 typically = 55.7 Ω

R_{T-G} is the test-to-ground resistance – see resistor drawing. Typical Test Resistor = 55.7 Ω

4.4.1.2 Overcurrent Alarm

The NGR Over-Current setting (OVERCURRENT ALARM) is used to alarm when Ground Faults exist. The alarm “**NGR OVERCURRENT**” will be triggered if the current on the neutral exceeds this value.

NOTE: The value needs to be below the maximum current permitted to flow with a direct bolted phase to ground fault, as determined by system voltage and the resistor tap setting, and above the charging current test result.

4.4.1.3 System Voltage

This setting is set during start-up and should match the system's L-L voltage. SYSTEM VOLTAGE is used for the system charging current algorithm.

4.4.1.4 Reset Mode

When in Manual Mode, if an alarm occurs, the horn will sound, and the Fault Light will flash until acknowledged. Pressing the **ALARM ACK** button will silence the horn and cause the Fault Light to stop flashing. Once the alarm clears and after the Ground Fault Test Timer times out, the alarm fault light can be cleared, and the system reset by pressing the **SYSTEM RESET** button. To reset the system, the alarm must not be active, and the Ground Fault Test Timer must time out. You will see no active fault on the home screen.

When in Automatic Mode, any alarm that is triggered, will be reset when the alarm conditions go away, and after the Ground Fault Test Timer times out. The Fault Light will go out and the Normal Light will illuminate.

4.4.2 Alarm Timers

4.4.2.1 GF Alarm Delay

The Ground Fault Alarm Delay will determine how long a fault condition exists prior to an alarm being generated. It is default set to 10 second to avoid any short-term intermittent faults.

4.4.2.2 GF Alarm Resend

The Ground Fault Alarm Resend Timer will recycle the auxiliary alarm contacts for the "System Fault", and the "Ground Fault, each time this timer times out.

4.4.2.3 Pulse Tap ON/OFF

The Pulse Tap On/Off timer will determine the length of time the pulse relay is engaged. The pulse relay is used to vary the NGR resistance making it easier to find a ground fault. *See section 6 Finding a Ground Fault for details.* The relay will be off for the same period of time it is on.

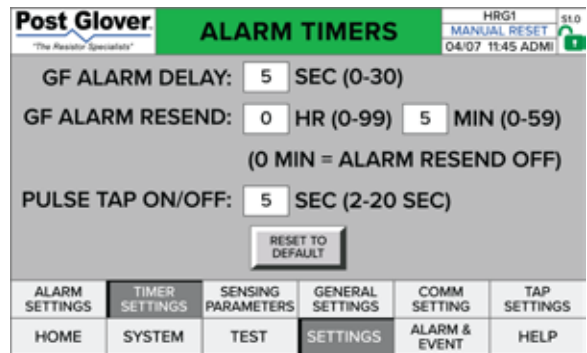

NOTE: Pulsing automatically turns off after 4 hours to keep the contactor from fusing. Pulsing can be restarted by simply pressing the **PULSE** button.

4.4.3 Resistor/Neutral Health Sensing

The Sensing values menu features all the settings for the resistor and neutral sensing features. *For more details on the sensing methods used by the SmartPulse see section 7.*

4.4.3.1 Resistor Sensing Enable

Use the touch button slider to turn on or off Resistor Sensing. *For more details on Resistor Sensing see section 7.1*

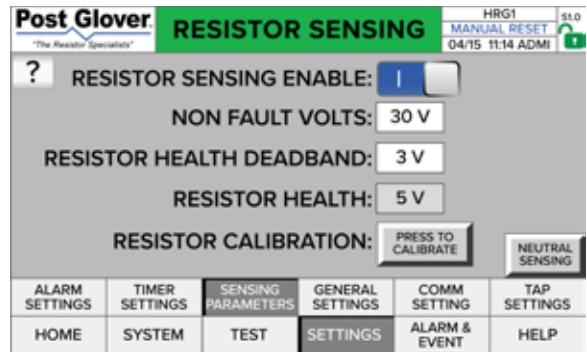

4.4.3.2 Non-Fault Volts

The Non-Fault Voltage setting is used to turn off resistor sensing once the neutral voltage has reached an elevated value. Generally, this value should remain the default of 30V unless the HRG frequently has above 30V on the neutral and Neutral sensing is disabled.

4.4.3.3 Resistor Health Deadband

The Resistor Health Deadband determines the sensitivity of the Resistor Sensing alarm. The higher this value is set the more the system will need to vary from the calibration point for an alarm to occur.

4.4.3.4 Resistor Health

The Resistor Health field is a calculated value that cannot be changed. This value along with the deadband are used to determine the health of the resistor using resistor sensing.

4.4.3.5 Resistor Calibration

The Resistor Calibration should be completed after initial installation and anytime the resistor is disconnected for maintenance. It is an internal calculation that views the resistance of the resistor circuit and is used for the resistor health calculation.

4.4.3.6 Neutral Sensing

From the Neutral Sensing menu this feature can be enabled or disabled and the neutral sensing start time can be set. The neutral sensing start time should be entered in 24 hour format. *SmartPulse see section 7.2.*

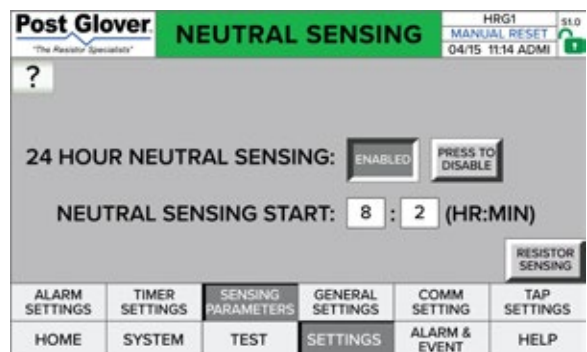

4.4.4 General Settings

4.4.4.1 DEVICE1 Name

Device name is a field that can be used to more accurately label the circuit that the HRG is connected to. This can be particularly helpful on Generator and Utility mix circuits that use multiple HRGs.

4.4.4.2 Outdoor Mode

Outdoor Mode is a toggle that be used to change the background color of the main display in a bright environment. Outdoor mode is not required for outdoor applications.

4.4.4.3 Date and Time Settings

Use these fields to enter the Date and local Time for the unit. These settings are often set during original commissioning.

4.4.5 COMM Settings

Use these fields to enter the desired ethernet communication settings if applicable.

Press the **RS-485** button to access the screen for the Modbus settings.

NOTE: See the communications manual for more information on Ethernet and Modbus communications.

4.4.6 Tap Settings

The tap settings for the HRG are physically set with the cam switch internal the unit. The settings in the Tap Settings menu should match those set by the switch.

4.4.6.1 Ground Current Tap

From the drop down select the ground fault setting on the unit. This should be the desired fault current during a fault. This value is displayed first on the Cam Switch.

4.4.6.2 Pulse Current Tap

From the drop down select the pulse fault setting on the unit. This should be the desired pulse amperage during a ground fault with the pulse feature activated. This value is displayed second on the Cam Switch.

4.4.6.3 Test Current Tap

Press the amp value box to set the test current setting on the unit. This should be the desired amperage on the test resistor based on a solidly grounded system. This value will be 5 amps for most units. The nameplate on the unit will show the factory installed tested resistor value.

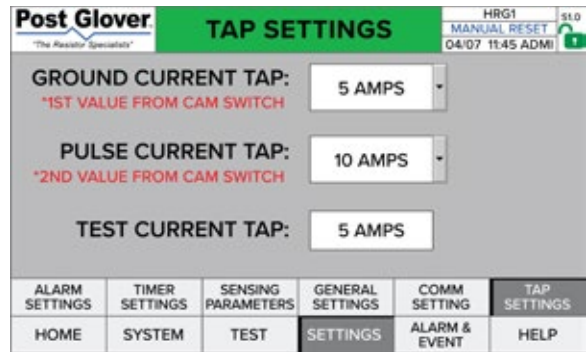

4.5 System Tests

The password must be disabled to perform tests. Only qualified persons should perform testing. **Abide by all Electrical Safe Work Practices to perform System Tests.**

NOTE: A user with testing permissions must be logged in for completing test. See section 8.3 for details on logging in/disabling the password.

4.5.1 Test Resistor

The Ground Fault Test places a ground fault on the system using the supplied system voltage at SW1. The test relay in the LDEM will close and current will flow through the test resistor bank to ground and from ground to the NGR bank, back to the system neutral. See section 3.3.6 for more information. The unit should alarm during this test to signify a passing result.

4.5.2 Pulse Test

The Pulse Test begins the same way as the Test Resistor test. After 10 seconds, when the Test Resistor Test would alarm, the unit should begin pulsing. During this pulsing process the NGR amps should oscillate up and down every 2 seconds.

4.5.3 System Charging

The System Charging current test initiates test circuit described above to calculate the system charging current. The maximum charging current on the system will only be detected and displayed if all available circuits on the system are connected to the system. Each branch circuit must have all disconnects, breakers, or other connecting means closed. See section 3.3.7 and section 5.1 for more information.

4.5.4 Test RES History and SYS CHRG History

The Test Resistor history and System Charging History can be viewed to see the historical data of past tests on the unit. This can be used as a way to view the changes to a system over time.

4.5.5 Pulsing

During a ground fault navigate to the Pulsing tab to initiate pulsing. After pressing the **START** button the unit will pulse for 4 hours. See section 6 for more information on pulsing.

Post Glover		TEST RESISTOR		HRG1	
"The Resistor Specialists"				MANUAL RESET	
				04/07 11:44 ADMIN	
		ACTUAL	TARGET		
NGR VOLTS	0.0 V	138.6 V			
NGR AMPS	0.0 A				
TEST RES. AMPS	0.0 A	2.5 A			
START		PRESS START BUTTON			
STOP					
TEST RESISTOR	PULSE TEST	SYSTEM CHARGING	TEST RES. HISTORY	SYS CHRG HISTORY	PULSING
HOME	SYSTEM	TEST	SETTINGS	ALARM & EVENT	HELP

Post Glover		SYS CHARGE TEST		HRG1	
"The Resistor Specialists"				MANUAL RESET	
				04/07 11:44 ADMIN	
		ACTUAL	TARGET		
NGR VOLTS	0.0 V	138.6 V			
NGR AMPS	0.0 A				
TEST RES. AMPS	0.0 A	2.5 A			
SYS CHRG AMPS		0.0 A			
START		PRESS START BUTTON			
LAST PERFORMED: 04/07/2022 10:51					
TEST RESISTOR	PULSE TEST	SYSTEM CHARGING	TEST RES. HISTORY	SYS CHRG HISTORY	PULSING
HOME	SYSTEM	TEST	SETTINGS	ALARM & EVENT	HELP

Post Glover		PULSING		HRG1	
"The Resistor Specialists"				MANUAL RESET	
				04/07 11:44 ADMIN	
		NGR VOLTAGE	0.0 V		
		NGR CURRENT	0.0 A		
NO ACTIVE GROUND FAULT EXISTS: UNABLE TO START PULSING					
START		STOP			
TEST RESISTOR	PULSE TEST	SYSTEM CHARGING	TEST RES. HISTORY	SYS CHRG HISTORY	PULSING
HOME	SYSTEM	TEST	SETTINGS	ALARM & EVENT	HELP

4.6 Alarm Notification

4.6.1 Normal

- When the top center background of the display is green, the system does not detect any of the Alarms being monitored.

4.6.2 Fault

- Alarm Mode in manual
 - When the top center background of the display is red, one of the alarms *listed in section 9.1* has occurred and not yet cleared or is still active. The password will need to be entered and the system reset to return to normal after the fault condition has cleared.
- Alarm Mode in automatic
 - When the top center background of the display is red, one of the alarms *listed in section 9.1* has occurred and not yet cleared or is still active. The unit will return to normal after the fault condition has cleared.

4.7 Alarm Horn

The alarm horn sounds when a fault occurs. Press the **Acknowledge ALARM** button from the system screen to silence the horn.

Section 5 – Charging Current & Resistor Tap Setting

5.1 System Charging Current

5.1.1 General

In ungrounded systems, a voltage is held on the system capacitance after a fault. In an arcing or intermittent fault, this can lead to a significant voltage build-up. In a high resistance grounded system, the resistance must be low enough to allow the system capacitance to discharge, thereby preventing significant voltage build-up.

The magnitude of zero-sequence charging current is determined by the line-to-ground capacitance associated with system components. The value of this current must be known to properly coordinate the Post Glover Resistors High Resistance Grounding System. In an industrial power system where the design and components are known, the charging current can be estimated with reasonable accuracy.

With a complex array of machines and cables, this may be tedious and yield less-than-accurate results. During the startup procedure, a System Charging Current Test will be performed. The system charging current will be used to determine the NGR tap setting, which in turn determines current permitted to flow during a ground fault. *See section 5.2 for details.*

5.1.2 System Charging Current Test

The most accurate way to determine the maximum value of the charging current is by test since extreme variations can exist. The charging current per phase is represented by I_{CA} , I_{CB} or I_{CC} , while I_C corresponds to the total line-to-ground charging current. To obtain the zero-sequence charging current, one phase conductor is intentionally grounded as shown in the schematic below. **The test should be performed with all system equipment connected and in the circuit.** Repeating the charging current test is necessary with a significant system change.

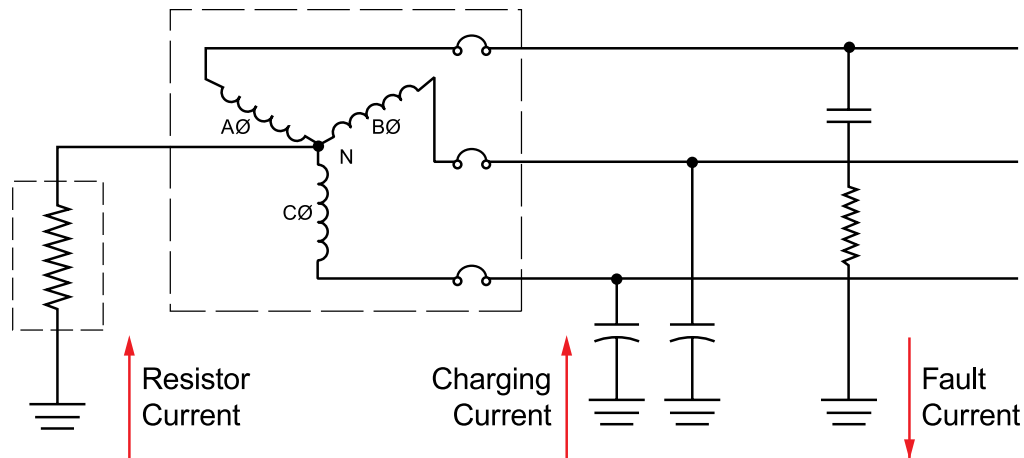

$$I_C = \frac{V_{RATED}}{\sqrt{3}V_R} \sqrt{I_F^2 - I_R^2}$$

V_{RATED} = System Voltage taken from System Values Screen
 V_R = Measured Resistor Voltage
 I_F = Fault current measured at test resistor
 I_R = Measured Grounding Resistor Current

5.1.3 Test Results

The resulting value is to be used to determine the minimum current for ground fault alarming, meaning the OVERCURRENT ALARM setting in the Alarm settings should not be above the System Charging Current Results.

5.2 Resistor Tap Connection

Using the switch, the resistor taps should be set at installation so that ground current with a ground fault is greater than or equal to the system capacitive-charging current.

The first number on the switch represents the pre-determined amperes that will be allowed to flow during a bolted fault. The second value is the current that will flow when the pulse is active during a fault. In the example below the unit is set to have a 3-amp ground fault with a 5-amp pulse.

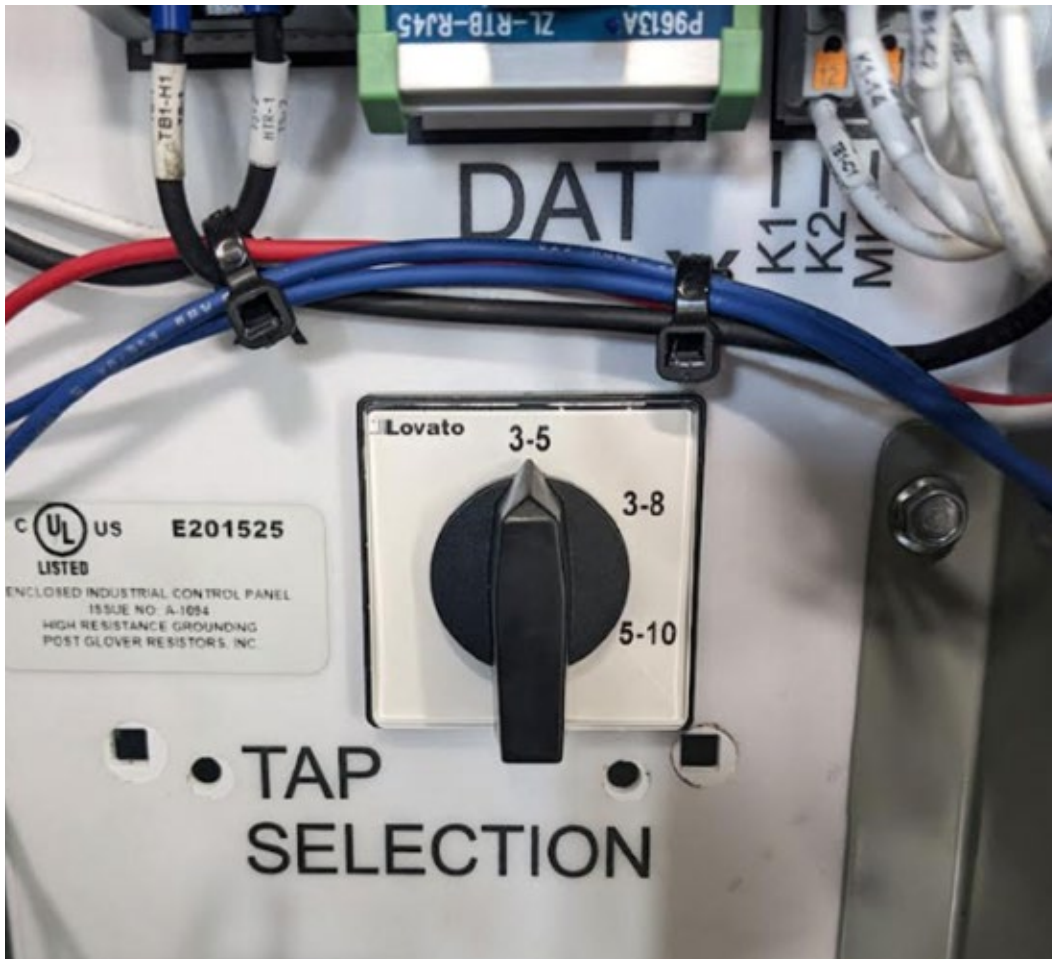

Section 6 – Locating a Ground Fault/Using Pulse

To locate a ground fault, activate the pulsing circuit by pressing the **PULSE** button on the operator’s panel. The pulsing circuit cannot be enabled unless there is a ground fault detected by the SmartPulse. After pressing the button, the controller will display the “Pulser Running” screen. This screen shows the pulse rate in seconds and the neutral voltage and current. This activates a control circuit which causes a cyclic switching sequence. The switching sequence consists of the cycle timing of an integral pulsing relay (PX). The pulsing relay (PX) shorts out a portion of the grounding resistor (NGR) each time the relay is energized, producing a tracer signal.

The optional portable hook-on detector is then used to follow the tracer signal through the system to the point of the fault. The detector is clamped around all three phases of each individual feeder (*see the schematic below*). The feeder with the fault will show rhythmic fluctuations on the detector’s readout. The fault can be traced to the sub-feeder and eventually to the faulted device. Once this location is determined, the pulsing contactor should be turned off by pressing the **PULSE** on the operator’s panel. This will return the user to the “System Status” screen.

After clearing the fault, place the system in its normal operation mode by pressing the **SYSTEM RESET** button.

NOTE: A portable ammeter can be included as an option with the SmartPulse.

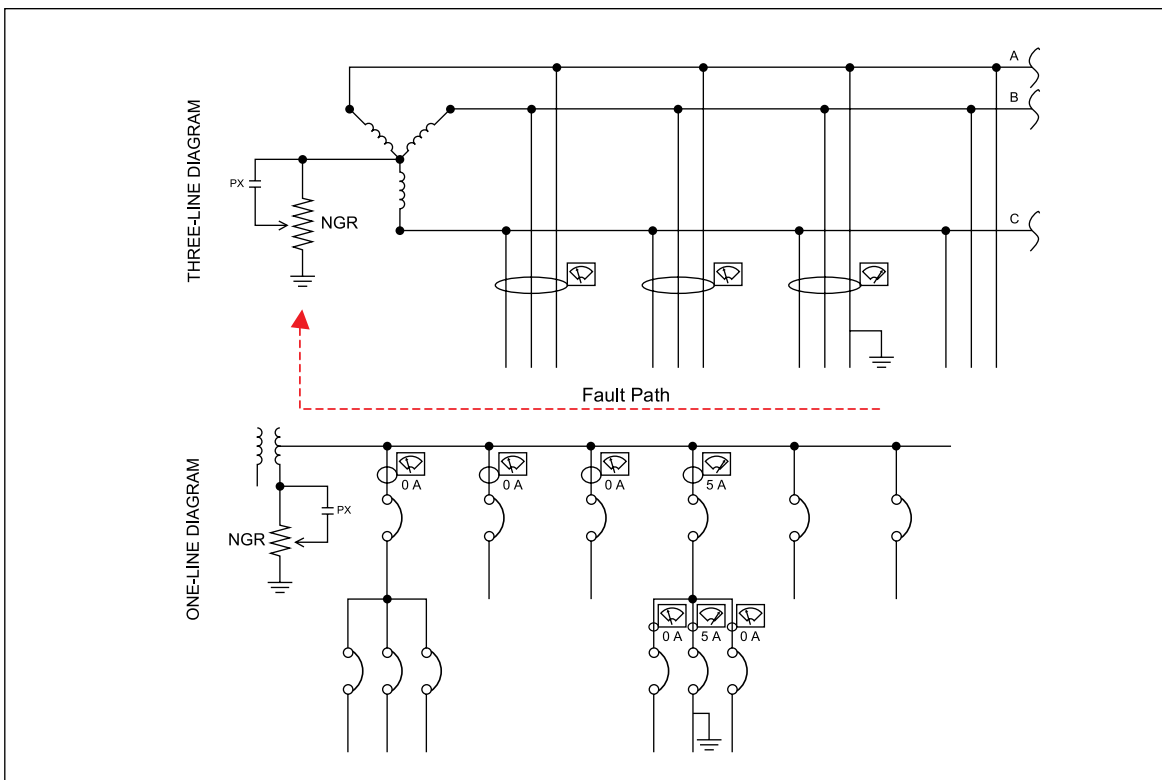

How to Locate a Ground Fault

Section 7 – Neutral Health Monitoring

For all High resistances grounding systems, it is required for the neutral to be monitored. Outside of the standard fault monitoring via current and voltage actively on the neutral of the system the SmartPulse uses additional methods for monitoring the health of the neutral grounding resistor. The methods used are **Resistor Health Sensing** and **Neutral Health Sensing**.

7.1 Resistor Health Sensing

Resistor Health Sensing is a method used to verify the health of the actual resistor circuit. When resistor sensing is enabled the LDEM will continuously verify the state of the resistor circuit compared to the last calibrated state of the resistor. For this reason, it is important to recalibrate the resistor health once major system changes have occurred. The resistor health deadband can be used to control the sensitivity of this check. Resistor Health Monitoring is enabled by default. *See Section 9.2 for more details on specific alarms that can be generated by grounding resistor faults.*

7.2 Neutral Health Testing

Neutral Health testing is a method used to verify the complete connection of the SmartPulse system from the neutral(X0) connection point through the resistor to ground. This test runs automatically once per day during the time set in the neutral testing section of the settings. Neutral Health Testing is disabled by default for the reason noted below.

NOTE: *This setting can cause nuisance alarm for unit that do not have continuous transmission power. It is recommended to be disabled for all units on intermittent generator power. For units in initial commissioning, it should remain disabled until continuous transmission power is provided.*

NOTE: *During the daily Neutral Health Test the resistors will see phase voltage for a few seconds during the test. This may produce incidental heat.*

Section 8 – Password Protection and User Permissions

The SmartPulse High Resistance Grounding System offers multiple Users that have varying levels of clearance to change settings or perform system tests. An administrator level user has full access to the settings and tests available to an end user. A maintenance level user has access to the features needed for normal operation of the HRG. Reviewing settings, silencing alarms, and activating the pulse feature do not require a user login. *Refer to table below for more details.*

8.1 User Permission Table

Action	User Level		
	Login Not Required	Maintenance	Administrator
Acknowledge Alarm	X	X	X
Acknowledge Event in Event Table	X	X	X
Startup Acknowledge Alarm	X	X	X
Toggle Outdoor Mode	X	X	X
Start/Stop Pulse	X	X	X
Alarm Settings		X	X
Alarm Timers		X	X
Begin FAT Process		X	X
Change NGR Health Settings		X	X
Change Resistor Sensing Settings		X	X
Change System Settings		X	X
Change Tap Settings		X	X
Clear Alarm and Events Tables		X	X
Clear Sys Charging Table		X	X
Enable/Change X0 Neutral Sensing		X	X
FAT Device Settings		X	X
Restart HMI		X	X
Start / Stop Test Resistor Test		X	X
Start/Stop Pulse Test		X	X
Startup Device Configuration		X	X
System Charging Test		X	X
Toggle Startup Complete		X	X
Add/Delete Users			X
Change HMI Communication Settings			X
Change RS-485 Comm Settings			X
Change Smart Relay IP Address			X
Download Software			X
Manage Users			X
System Reset			X

8.2 Default Passwords

USER LEVEL		
Login Not Required	Maintenance	Administrator
NA	2000	3000

8.3 Disabling the Password Protection/ Logging into a User Profile

To disable the password protection, you must log into a user profile. To login do the following steps:

- Click the lock in the top right corner of the screen.
- Click the **USER NAME** box and select the desired user profile.
- Click the password box currently displaying "0"
- Enter the correct password for the user followed by enter.
- Default passwords can be in the table above
- Click **Login**.
- The lock in the top right corner should now be open.

The screenshot shows the 'Post Glover' interface with a green 'LOGIN/OUT' header. The main area contains a login form with the following fields and buttons:

- USER NAME:** A dropdown menu currently showing 'ADMINISTRATOR'.
- PASSWORD:** A text box containing '0'.
- CURRENT USER:** A text box containing 'ADMINISTRATOR'.
- LOGIN TIME:** Two input boxes showing '2 hr' and '0 min'.
- Buttons:** 'Login', 'Logout', 'Manage Users', and 'Restart HMI'.
- Top Right:** A lock icon, a 'MANUAL RESET' button, and a status display showing 'HRG1', '04:07 11:45 ADMI', and 'SLO'.
- Bottom Navigation:** A row of buttons: 'HOME', 'SYSTEM', 'TEST', 'SETTINGS', 'ALARM & EVENT', and 'HELP'.

Section 9 – Troubleshooting Alarms and Events

The Alarm and Event tables will log which alarms or events have occurred, when it occurred, what the values detected were at the time, and when the system returned to a normal state. Any active alarm states will be displayed on the home screen with additional information.

9.1 Alarm and Event Tables

9.1.1 Alarm Detail

This table displays the historical data of alarms on the system. It is capable of recording 200 alarms with FIFO event management. They are arranged chronologically with the most recent alarm appearing on top. See section 9.2 for detail on the 4 specific alarm types. Once alarm conditions have been clear from a unit the data tabled can be cleared by pressing the **CLEAR ALARMS** button. An administrator level login is required.

No.	Date	Time	Test Resistor Current	NGR Current	NGR Voltage	Alarm Ty
2	2022/12/01	15:02:03	2.0	1.9	172.0	1
1	2022/12/01	15:02:03	0.3	0.3	2.1	4
0	2022/12/01	15:00:10	0.3	3.1	277.0	1

9.1.2 Event Detail

This table displays the historical data of events that have occurred in the SmartPulse system. It is capable of recording 200 events with FIFO event management. They are arranged chronologically with the most recent event appearing on top. The events table can be cleared by pressing the **CLEAR** button. An administrator level login is required.

No.	Date	Trigger	Event
73	2022/12/01	14:59:29	NGR CALIBRATED
72	2022/12/01	14:59:13	RESISTOR SENSING DISABLED
71	2022/12/01	14:58:11	RESISTOR SENSING ENABLED
70	2022/12/01	14:58:04	SYSTEM CHARGE CALCULATION COMPLETE
69	2022/12/01	14:57:55	NGR VOLTAGE RETURNED TO NORMAL

9.2 Alarm Types

9.2.1 Alarm Type 1 – Ground Fault

This alarm indicates the unit has experienced a phase to ground fault. The unit identifies a ground fault as any time the voltage or current exceed the values set at the alarm settings for Overvoltage, or Overcurrent. See section 4.4.1 for more information. This alarm will stay active until the ground fault clears. The pulse function may be used to help locate for the fault. See section 6 for details on fault detection.

9.2.2 Alarm Type 2 – NGR Short

This alarm indicates the electronics module has detected a short between neutral and ground in the SmartPulse unit. The unit identifies an NGR short alarm using the Resistor Health Sensing settings see section 4.4.3 and section 7 for more information. To troubleshoot this alarm, verify the resistance from neutral to ground and confirm that the resistor is not shorted.

9.2.3 Alarm Type 3 – NGR Unground

This alarm indicates the electronics module has detected an open circuit between neutral and ground in the SmartPulse unit. The unit identifies an NGR Open alarm using the Resistor Health Sensing settings *see section 4.4.3 and section 7 for more information*. To troubleshoot this alarm, verify the connection from the unit's neutral to ground through the resistor is not Open.

9.2.4 Alarm Type 4 – Open Neutral

This alarm indicates the unit has detected an open circuit between neutral and ground in the connection from neutral(X0) to ground. The unit identifies an Open Neutral alarm using the Neutral Health Test settings *see section 4.4.3.2 and section 7 for more information*. To troubleshoot this alarm, verify the connection from X0 to ground through the resistor is not Open.

Alarm Type	System Condition	Alarm If
1 – Ground Fault	Ground fault in distribution system	Neutral Voltage exceeds Overvoltage Alarm Neutral Current exceeds Overcurrent Alarm
2 – NGR Short	Short circuit in resistor path within HRG cabinet (does not detect alternate grounds in the customer system)	Resistor Health value is less than Resistor Health Deadband for 10 seconds
3 – NGR Unground	Open circuit in resistor path within HRG cabinet	Resistor Health value exceeds Resistor Health Deadband for 10 seconds
4 – Open Neutral	Open circuit in resistor path between source neutral connection and ground	NGR Voltage<30, NGR Current and Test Resistor Current=0, or Test Resistor Current ≠ NGR Current for 6 seconds

9.3 Events

The SmartPulse High Resistance Grounding system considers all noncritical system changes events. These include user login/logouts, system test, alarm states clearing, operator mode changes, and pulsing activation. Events can be used in conjunction with alarms to track exactly when intermittent faults occur and clear to provide additional information for fault troubleshooting.

Section 10 – Maintenance

Normally, no maintenance is necessary for the SmartPulse high resistance grounding system. However, periodic inspections are needed to ensure that the controller is functioning correctly and the resistor is still capable of protecting the system. Post Glover Resistors recommends that the periodic inspections coincide with your normal system Preventative Maintenance schedule.

The following procedure is recommended for periodic field inspections:

1. De-energize the system being grounded. Open the front panel and open the disconnect switch on the SmartPulse, which will de-energize the control circuits and isolate the connection between the system neutral and ground. Always use proper lock-out/tag-out procedures when working on electrical equipment.

WARNING: *Danger: High Voltage*

AVERTISSEMENT: *Danger: Haute Tension*

2. Remove the back panel of the free-standing enclosure. This will allow for a visual inspection of all internal components.
3. Check the enclosure for signs of damage from weather or rodents. Remove any dirt or debris from the inside of the enclosure using a vacuum cleaner.
4. Carefully check for cracked insulators and resistor cores. A MEGGER or Hi-Pot test is the most reliable method of ensuring that the insulation is still providing the necessary electrical isolation. Remove any connections from the resistor elements to ground and the controller before performing one of these tests.
5. With the disconnect switch open, check the resistance between the neutral (at the bottom of the disconnect switch) and ground (green terminal block on the DIN rail). This measurement should be within 10% of the value chosen on the current levels selector switch. If the measurement is more than 15% different from the switch value, connections should be checked and/or resistors replaced.
6. Check all internal connections for tightness. Check wiring for signs of damage from heat or overloads.
7. Replace all side covers removed during inspection and check the mounting bolts for tightness. Close the front door of the control enclosure.
8. After re-energizing the system, perform the Test procedure in *section 4.5* to verify system operation.
9. FOR REPLACEMENT PARTS OR ASSISTANCE, CALL 1-800-537-6144 (or from outside the USA, +1-859-283-0778) or e-mail sales@postglover.com. Please have the resistor nameplate information readily available when you call.

Section 11 – Troubleshooting by Symptom

11.1 Fault Light ON:

1. When a fault has occurred, an alarm will be displayed and recorded.
2. Active faults are displayed in the middle of the Home Screen. Determine if the fault is still active.
3. If the fault is not active, an event will be recorded, indicating when the fault condition returned to normal.
4. The Alarm Table above identifies which parameter setting is being used to trigger the alarm and “**Alarm If**” information.
5. Many ground faults will have two alarms associated with the fault: Max Voltage, and or Max Current. For active Ground Faults, *refer to section 6 Locating a Ground Fault.*

11.2 No information on display:

1. Is 24VDC power available? Check the voltage at the power supply output terminals with the disconnect switch in the ON position. If there is no voltage present, check the fuses and the source 120VAC power.
2. Is the controller power cable secure? Verify that the connection between the controller and base panel is firmly connected.
3. If both of the above check out OK, consider replacing the controller.

11.3 TEST button does not seem to function properly (no alarm):

1. Verify password has been entered.
2. Do the voltage and current readings on the display increase?
 - a) If so, the High Limits may need to be lowered for the fault to register.
 - b) If not, there may be an installation issue, such as the Neutral wire for the HRG not connected to X0 on the transformer.
3. Is there heat coming from the test resistor? Check by feeling for warm air from the exhaust vent of the resistor enclosure. If there is heat and there is no voltage and current reading on the NGR, this condition is indicative of a solidly-grounded neutral. Check the transformer X0 bushing and the switchgear to make sure that all connections between neutral and ground are removed.

For further assistance, press the **HELP** button, and use the contact information provided to contact Post Glover Resistors. When contacting Post Glover Resistors, please provide the following:

1. The name/type of alarm
2. The SO Number for the equipment, which can be found on the black label on each Post Glover Resistors Unit
3. Any details which may be pertinent.

Appendix A – Dimension Drawings, Low Voltage Enclosure

Refer to the specific order drawings for the resistor for connections and more detailed dimensions.

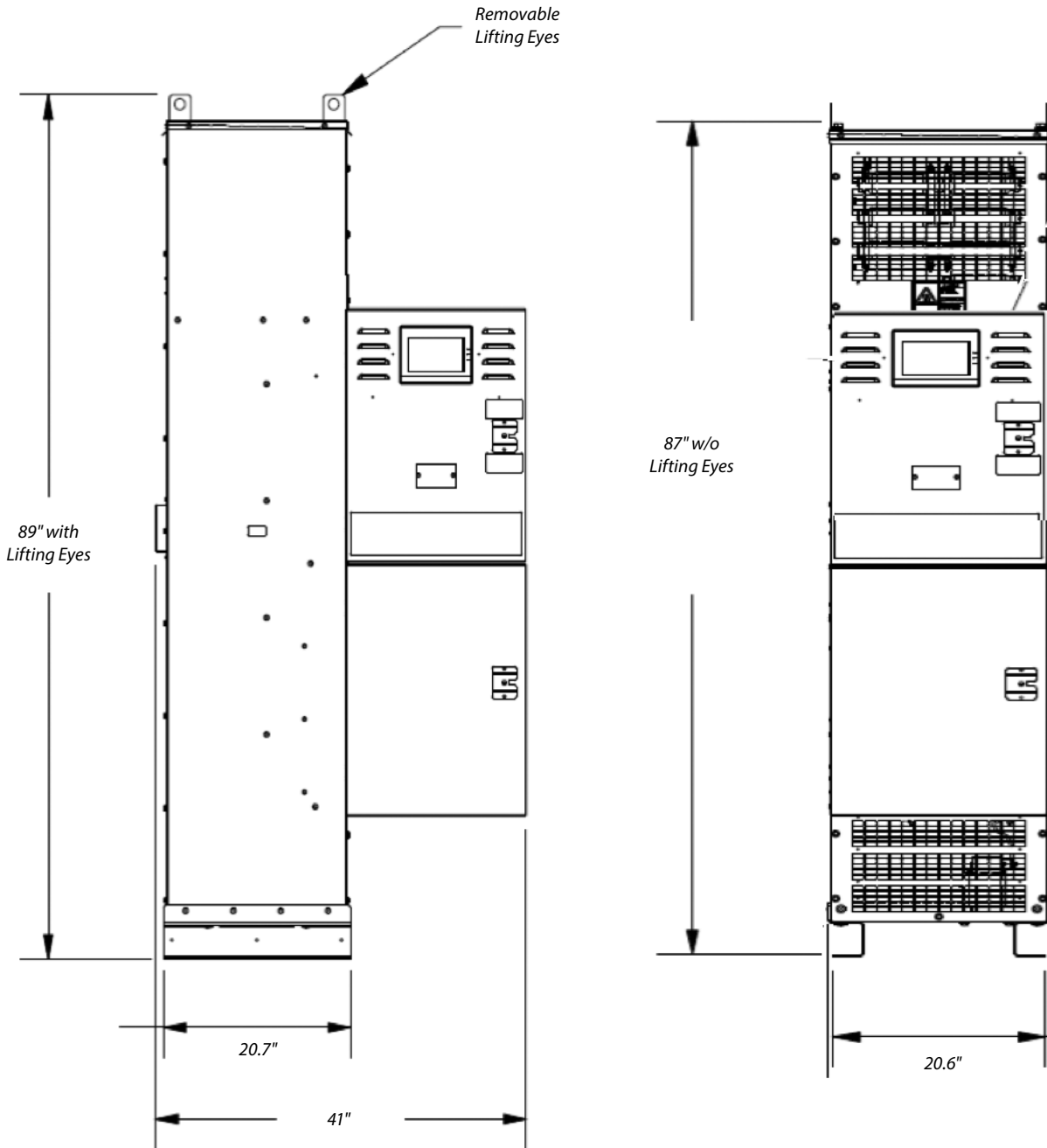

Appendix B – Customer Connection Details

B.1 Freestanding Unit

The tables below indicate the wiring requirements to connect the SmartPulse to the customer equipment. For each wire, the ending termination locations at the SmartPulse are given along with the wire temperature rating, size, color and termination requirements.

Wye unit without control power transformer:

Terminal 1	Termination Type	Terminal 2	Termination Type	Wire Temp	Wire Size	Wire Color
SW1-1	0.625" stripped wire	Xfmr/Gen X0	By customer	60/75C	#8	White
SW1-5	0.5" stripped wire	Swgr. L3	By customer	60/75C	#14	Black*
CFU5-1	0.5" stripped wire	Cust 120VAC Line**	By customer	60/75C	#18 to #14	Red
TB1-N	0.5" stripped wire	Cust 120VAC Neutral**	By customer	60/75C	#18 to #14	White

Wye unit with control power transformer:

Terminal 1	Termination Type	Terminal 2	Termination Type	Wire Temp	Wire Size	Wire Color
SW1-1	0.625" stripped wire	Xfmr/Gen X0	By customer	60/75C	#8	White
SW1-3	0.5" stripped wire	Swgr. L2	By customer	60/75C	#14	Black*
SW1-5	0.5" stripped wire	Swgr. L3	By customer	60/75C	#14	Black*

Delta unit without control power transformer:

Terminal 1	Termination Type	Terminal 2	Termination Type	Wire Temp	Wire Size	Wire Color
SW1-1	0.5" stripped wire	Swgr. L1	By customer	60/75C	#14	Black*
SW1-3	0.5" stripped wire	Swgr. L2	By customer	60/75C	#14	Black*
SW1-5	0.5" stripped wire	Swgr. L3	By customer	60/75C	#14	Black*
CFU5-1	0.5" stripped wire	Cust 120VAC Line**	By customer	60/75C	#18 to #14	Red
TB1-N	0.5" stripped wire	Cust 120VAC Neutral**	By customer	60/75C	#18 to #14	White

SMARTPULSE™ INSTRUCTION MANUAL

Delta unit with control power transformer:

Terminal 1	Termination Type	Terminal 2	Termination Type	Wire Temp	Wire Size	Wire Color
SW1-1	0.5" stripped wire	Swgr. L1	By customer	60/75C	#14	Black*
SW1-3	0.5" stripped wire	Swgr. L2	By customer	60/75C	#14	Black*
SW1-5	0.5" stripped wire	Swgr. L3	By customer	60/75C	#14	Black*

*The three-phase wire color can be the customer's standard colors, such as Brown, Orange, Yellow, etc.

**Customer must provide remote disconnecting means for 120VAC control power circuit.

B.2 Wall-Mounted Unit

In addition to the connections above, the wall-mounted unit requires connections between the wall-mounted control unit and the freestanding resistor unit. These additional connections are in the following table:

Terminal 1	Termination Type	Terminal 2	Termination Type	Wire Temp	Wire Size	Wire Color
LDEM-4	Panduit FSD80-8-D	TBR-T	Burndy YAV14	60/75C	#14	Black
LDEM-6	Panduit FSD83-18-C	TBR-N	ILSCO CSWS-8-8	60/75C	#8	White
LDEM-7	Panduit FSD83-18-C	TBR-P	ILSCO CSWS-8-8	60/75C	#8	White
LDEM-8	Panduit FSD83-18-C	GNDB#	By customer	60/75C	#8	Green
TBR-F	ILSCO CSWS-8-8	GNDB#	By customer	60/75C	#8	Green
TB2-G	Panduit FDS76-8-D	GNDB#	By customer	60/75C	#18	Green

Terminal block TBR is located in the resistor cabinet.

#Customer ground bus GNDB provided as per applicable codes and standards.

Appendix C – Control Specifications

C.1 Ground Circuits:

1. Low Voltage HRG Digital Electronics Module (LDEM)
 - a) Voltage Limit: 600VAC
 - b) Current Limit: 30A

C.2 Controller Output Relays:

1. System Fault: 3A @ 120/230VAC, 2A @ 24VDC, 200mA @ 110VDC, 100mA @ 220VDC, refer to drawings for contact logic
2. Ground Fault: 3A @ 120/230VAC, 2A @ 24VDC, 200mA @ 110VDC, 100mA @ 220VDC, refer to drawings for contact logic

C.3 Communication Ports:

1. HMI Com1: 1 channel, RS-485
 - a) D-SUB, 9 pin male connector, refer to drawings for connector pin-out
 - b) Baud Rate: 1200 to 187500 bps
 - c) RS-485
 - i. Cable type: Shielded twisted pair
 - ii. Cable length: 1200m/4000ft maximum
 - iii. Nodes: Up to 255
2. Ethernet switch ESW:
 - a) 5-port 10/100Tx RJ45 Fast Ethernet
 - b) Auto MDI/MDI-X Function
 - c) Full/Half Duplex Mode
 - d) Cable length: 100m/328ft (Fast Ethernet)
3. Door mount Ethernet interface:
 - a) 22mm chromed plastic with polyamide boot
 - b) RJ45 Ethernet interface, minimum CAT 5E
 - c) IP65 degree of protection
 - d) UL 1, 3R, 4 degrees of protection

C.4 SD Card

1. HMI:
 - a) Type of Port: Micro SD adapter connected to USB Host port
 - b) Maximum Card size: 32GB
2. Smart Relay:
 - a) Type of Port: Micro SD slot with cover
 - b) Maximum Card size: 32GB

C.5 Miscellaneous

1. HMI Battery back-up: 3 years typical at 25°C
2. HMI Battery: Coin-type 3V, lithium ion manganese oxide (LMO) battery, CR2032
3. Maximum torque on connection screws, main disconnect switch: 2 N-m (17.7 in-lb).

Appendix D – Setup Report Form

These pages are intended as means of recording the parameters and settings used when commissioning the Post Glover Resistors SmartPulse. This is not a “how-to” guide, nor is it intended as a substitute for reading the manual.

INSTALLATION INFORMATION			
Unit ID:		Date:	
Customer:		NGR Tap: N	Amps
System Voltage:		Pulsing Tap: N	Amps
Part Number:		Maximum Time On:	Continuous
Serial No.:		Temp. Rise:	° Celsius

ROUTINE INSPECTION	
ENCLOSURE FINISH FREE OF DEBRIS?	Y / N
PHYSICAL INSTALLATION CORRECT?	Y / N
NEUTRAL AND GROUND TERMINATIONS PROPERLY CONNECTED?	Y / N
INTERNAL INSPECTION COMPLETED?	Y / N
CONTROL POWER CORRECTLY CONNECTED (CUSTOMER SOURCE OR CPT)?	Y / N
FIRMWARE VERSION INSTALLED:	
TIME AND DATE SET?	Y / N
CONTROL CIRCUIT OPERATIONAL TEST SUCCESSFUL?	Y / N
PARAMETERS SET AND EXPLAINED TO CUSTOMER?	Y / N
GROUND FAULT AND PULSING TAP SET TO CUSTOMER SPEC?	Y / N
GROUND FAULT AND PULSING TAP SET BASED ON TEST?	Y / N

NOTES

SMARTPULSE™ INSTRUCTION MANUAL

PARAMETER SETTINGS						
Setup Menu	Parameter	Default	Range	Setting	Section	
Alarm Settings	OVERVOLTAGE ALARM	60 V	0.0 – 9999.0			
	OVERCURRENT ALARM	4.0 A	0.0 – 9999.0			
	VRATED	480 V	0 – 9999			
	RESET MODE	MANUAL	AU / MN			
Alarm Timers	GF ALARM DELAY	10 SEC	0 – 30			
	GF ALARM RESEND	0 HR, 5 MIN	0 – 99 HR 0-59 MIN			
	PULSE RATE	5 SEC	2 - 10			
Sensing Parameters	RESISTOR SENSING ENABLED	OFF	ON/OFF			
	NON-FAULT VOLTS	30 V	0 – 30			
	RESISTOR HEALTH DEADBAND	3 V	1 – 4			
	RESISTOR CALIBRATION PERFORMED		Y / N			
	X0 NEUTRAL SENSING	DISABLED	EN / DIS			
	NEUTRAL SENSING TIME	-	24 HR CLK			
General Settings	DEVICE NAME	HRG1	-			
	OUTDOOR MODE	OFF	ON/OFF			
	DATE SETTING	-				
	TIME SETTING	-				
Comm Settings	SMART RELAY	IP ADDRESS	-			
	ETHERNET SETTINGS	IP ADDRESS	-			
		GATEWAY	-			
		SUBNET MASK	-			
	RS-485 SETTINGS	BAUD RATE	115200	Drop-down		
		TIMEOUT	3	0-9999		
NETWORK ID		64	0-9999			
Tap Settings	FAULT CURRENT TAP	Depends on specific ratings ordered				
	PULSE CURRENT TAP					
	TEST CURRENT TAP					

Customer Signature: _____

Date: _____

Technician Signature: _____

Date: _____

page intentionally left blank

Post Glover™

“The Resistor Specialists”

1369 Cox Avenue • Erlanger, KY 41018 • USA
Phone: 800-537-6144 / 859-283-0778 • Fax: 859-283-2978
www.postglover.com